

# OIL-FREE WATER-INJECTED SCREW COMPRESSORS

AQ 15-55 VSD/AQ 30-55 (15-55 kW / 20-75 hp)



*Atlas Copco*





## ***POWERFUL OIL-FREE AIR***

When it comes to clean, oil-free compressed air, you cannot afford to compromise on quality. Over the past decades, Atlas Copco has pioneered oil-free water-injected screw technology, resulting in a broad range of compressors delivering 100% oil-free, clean air. Setting the standard through ISO 8573-1 CLASS 0 certification, the AQ meets your need for pure oil-free air while offering best in class energy efficiency.

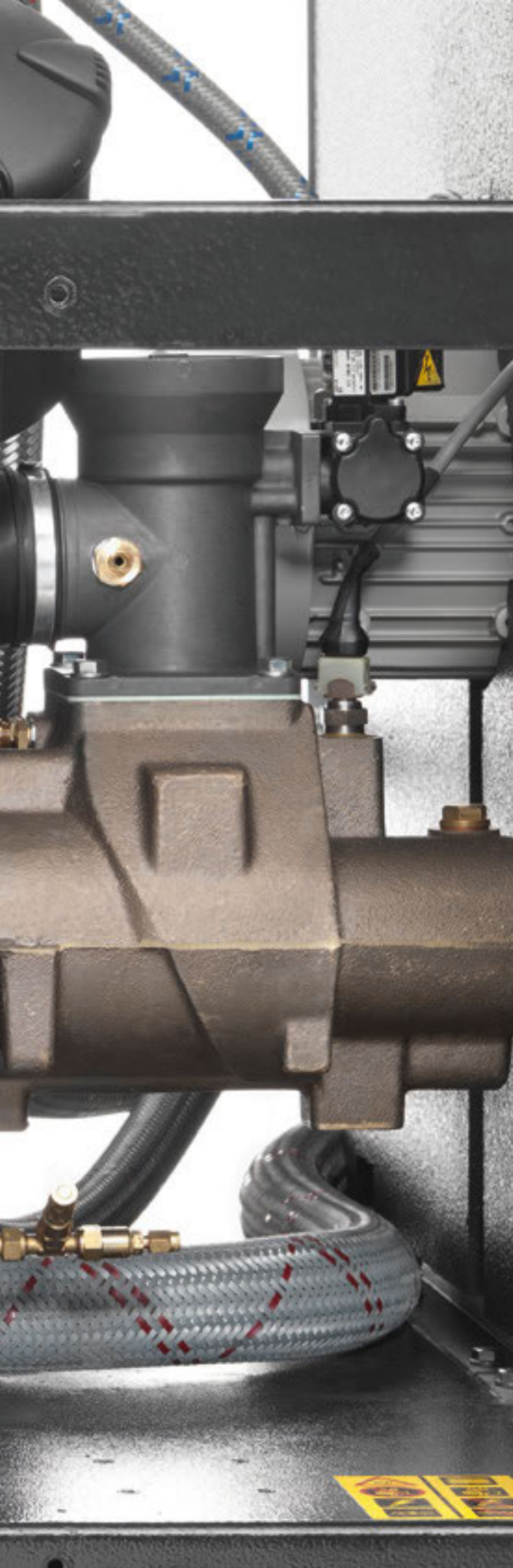

## Zero risk of contamination

Whether your activities are in pharmaceutical production, food & beverage, critical electronics or in a similarly exacting industry, air quality is paramount for your end product and production process. Atlas Copco's AQ oil-free compressors eliminate the risks of oil contamination.

## Reduced energy costs

With energy amounting to over 70% of a compressor's lifecycle costs (LCC), its importance is clear. The most efficient compressed air solution optimizes the pressure, volume and air treatment equipment for each production process. Atlas Copco's AQ compressors provide you with the ultimate all-in-one package to reduce your electricity bill to a minimum.

## Renowned expertise

Drawing on vast experience and continuous technological innovations, Atlas Copco has been leading the industry in oil-free compressed air technology for over sixty years. With the protection of your application in mind, Atlas Copco has designed its AQ range to offer the superb 100% oil-free quality air you are in need of.

# ENGINEERED TO MEET YOUR NEEDS

At Atlas Copco we aim to provide you with compressors that fulfill and even exceed your expectations and demands. Built as the result of decades of experience in oil-free design and manufacturing, the AQ range of oil-free screw compressors gives you all of this experience and knowledge in a class leading package.

1

## Water-injected screw element

- Highly energy-efficient thanks to low temperatures.
- Water-lubricated, grease-free bearings.
- In-house design and manufacturing.
- Working pressure up to 13 bar.

2

## Water filter

- Ensuring a constant supply of clean water.
- The filtration capability equals 10 micron throughout the filter's lifetime.

3

## Heavy-duty air filter

- Protects the compressor components by removing 99.9% of dirt particles down to 3 microns.
- Differential inlet pressure for proactive maintenance while minimizing pressure drop.

4

## Separator vessel

- Stainless steel water separator vessel for separation via centrifugal and gravity forces.
- Three sensors included for precise water regulation.



5

## Induction motor

- IP55 induction motor, flange-mounted for perfect alignment.
- Combined with direct driven arrangement for superior energy efficiency.





6

### Reverse osmosis system

The built-in reverse osmosis system provides a reliable supply of high quality water, ensuring autonomy and continuous operation.

7

### Air-cooled fan and water-cooler

- Air and water-cooled variants are available throughout the range.
- Small footprint and installation thanks to built-in heat exchangers.
- Water-cooled units provide a continuous air temperature at the dryer inlet of less than 55°C (131°F).

8

### Integrated highly efficient dryer

- Excellence in air quality.
- 50% reduction in energy consumption compared to traditional dryers.
- Zero ozone depletion.



9

### Elektronikon® Graphic

Advanced Elektronikon® Graphic control and monitoring system, designed for integration in a (remote) process control system.



10

### Sound insulated canopy

No separate compressor room is required as the sound insulated canopy allows for installation in most working environments.

11

### Electronic no-loss water drain

- Ensures constant removal of condensate.
- Manual integrated bypass for effective condensate removal in case of power failure.
- Integrated with compressor's Elektronikon® with warning/alarm features.



# PROVEN TECHNOLOGY

At the heart of the new AQ range is a unique water-injected screw element working highly efficient near isothermal compression. The polymer ceramic rotors with their optimized rotor profile are supported by water-lubricated bearings, ensuring that no oil whatsoever can contaminate the compression element, thereby producing pure oil-free air.

## Rotors

A highly efficient compression process is achieved thanks to high quality polymer mould ceramic rotors with optimum profiling. The combination of corrosion-free, high efficiency raw material and water lubrication results in a longer lifespan.

## Element housing

Strength and durability are ensured as a result of the aluminium bronze element housing without risk of corrosion within the element.

## Element bearings

The use of hydrodynamic bearings ensure long life as no physical contact is made within the bearing itself, it simply glides on a film of water removing the need for any oil or grease lubrication.

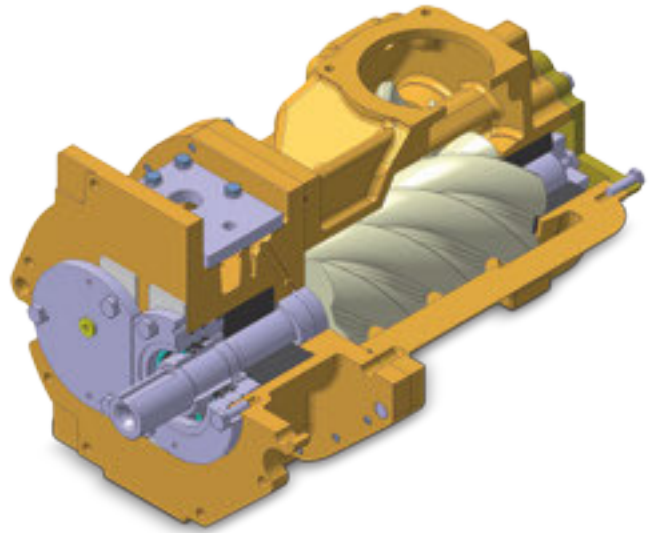

## Water-injected screw compression efficiency

The superior cooling capability of water ensures that the heat is removed efficiently at the source. Removing the wasted energy that heat represents gives more air per kW of power. The low temperature of the compressed air reduces the stress on components ensuring long life.

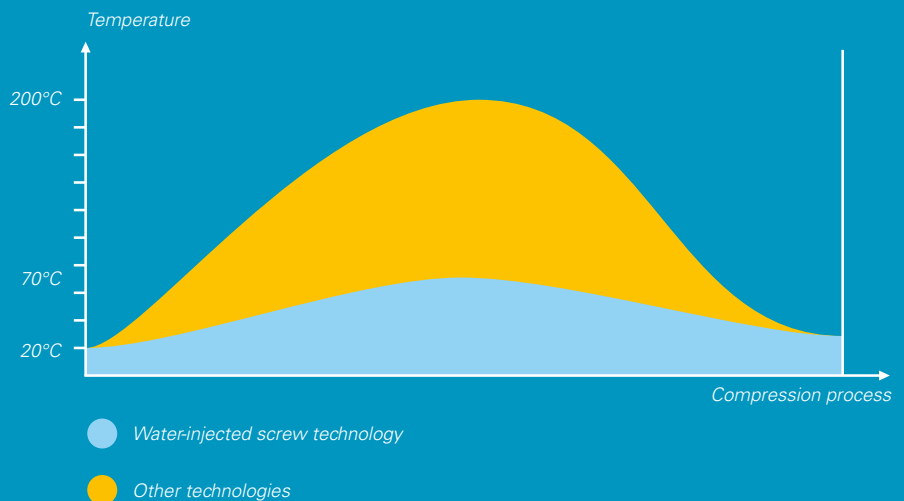

## Superior water-injected screw element

- Increased free air delivery.
- Low specific energy consumption.
- Near isothermal compression process.
- Pressure ratings of 7, 10 and 13 bar.

The highly effective cooling capabilities of water combined with precision engineering ensure the supreme energy efficiency of the AQ compressors.

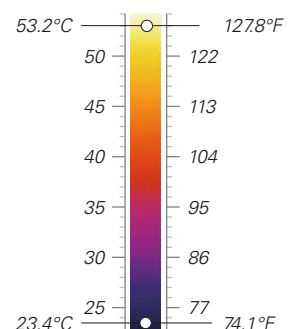

# EXCEPTIONAL VERSATILITY

Contrary to traditional compressor set-ups, Atlas Copco's AQ WorkPlace Air System compressors effortlessly fit onto your work floor. With their compact footprint and integration of air treatment equipment, AQ compressors ensure optimum efficiency and reliability. Designed to give the most versatile source of compressed air, they provide you with an all-in-one package that will have your production running smoothly for years to come.



## Oil-injected screw compressor set-up

- 1 High pressure drop across the system.
- 2 External filtration equipment/stand-alone dryer and condensate management.
- 3 Elaborate and costly piping system.
- 4 Multiple connections and air leaks.
- 5 Multiple monitoring points.

## Oil-free and WorkPlace Air System™

- 1 Minimum system pressure drop.
- 2 Integrated refrigerant dryer.
- 3 Reduced piping costs.
- 4 Single point connections.
- 5 Single point monitoring.

High noise operation

- ↳ Separate compressor room
- ↳ Raised installation & energy costs

Low noise operation

- ↳ No need for dedicated compressor room
- ↳ Minimized installation costs

# ISO 8573-1 CLASS 0

## ATLAS COPCO SETS A NEW INDUSTRY STANDARD

When it comes to clean, oil-free compressed air for your critical processes, you can't afford to compromise. Atlas Copco, a pioneer in oil-free air screw technology, is known for its range of water-injected compressors designed especially for applications that require oil-free air. Now Atlas Copco has achieved a new milestone: setting the standard for air purity as the first manufacturer to be certified ISO 8573-1 CLASS 0.

### Why a new class?

Industries such as pharmaceuticals, food and beverages, electronics and textiles must exclude any risk of contamination. Otherwise severe consequences could follow: spoiled or unsafe products, production downtime and damage to both brand and reputation. To address the needs of critical applications where air purity is essential, the ISO 8573-1 compressed air standard was revised in 2001. Along with a more comprehensive measuring methodology, a new and more stringent class was added to the five existing purity classes: ISO 8573-1 CLASS 0.

### First to achieve ISO 8573-1 CLASS 0

As the industry leader committed to meeting the needs of the most demanding customers, Atlas Copco requested the renowned TÜV institute to type-test its AQ range of oil-free water-injected screw compressors. Using the most rigorous testing methodologies available, all possible oil forms were measured across a range of temperatures and pressures. The TÜV found no traces of oil at all in the output air stream. Thus Atlas Copco not only became the first compressor manufacturer to receive CLASS 0 certification, but also exceeded ISO 8573-1 CLASS 0 specifications.

### Atlas Copco eliminates any risk

Only oil-free compressors deliver oil-free air. Whether your activities are in pharmaceutical production, food processing, critical electronics or a similarly exacting industry, it is essential to eliminate risk. That's why you need an Atlas Copco risk-free solution: oil-free screw compressors especially for applications demanding the highest levels of purity. Zero oil means zero risk. Zero risk of contamination. Zero risk of damaged or unsafe products. Zero risk of losses from operational downtime. Above all, zero oil means zero risk of ruining your hard-won reputation.

CLASS	Concentration total oil (aerosol, liquid, vapor) mg/m <sup>3</sup>
0	As specified by the equipment user or supplier and more stringent than class 1
1	< 0.01
2	< 0.1
3	< 1
4	< 5

Current ISO 8573-1 (2010) classes (the five main classes and the associated maximum concentration in total oil content).



## The most stringent air purity testing available

Most manufacturers prefer “partial flow” testing, which targets only the center of the air flow. The Atlas Copco AQ range of oil-free water-injected screw compressors was tested using the more stringent “full flow” method. This examines the entire air flow to measure aerosols, vapors and wall flow. Even with such rigorous testing, no traces of oil were found in the output air stream.

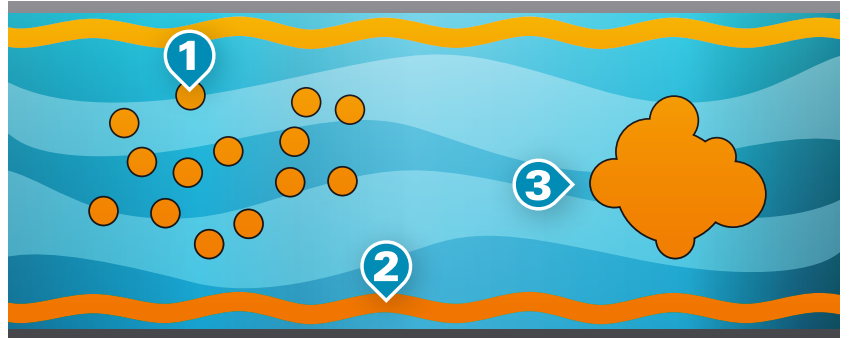

- 1** Aerosols  
Minute droplets of oil suspended in the air stream
- 2** Wall flow  
Oil in liquid form, which creeps along the pipe wall
- 3** Vapors or oil mist  
Vaporized oil in a cloud form



## Can oil-injected compressors with oil removal filters deliver oil-free air?

Often referred to as “technically oil-free air”, this system relies on air cooling devices and several stages of oil removal with multiple components. A failure of any of these components or inadequate maintenance can result in oil contamination of a process. Therefore, with oil-injected compressors there will always be a risk of contamination and the possibility of severe consequences for your business.

*TÜV (Technische Überwachungsverein/Technical Monitoring Association) reporting on the Atlas Copco AQ range of oil-free water-injected screw compressors.*

**Move up to a risk-free standard.  
Visit [www.classzero.com](http://www.classzero.com)**

# VSD: DRIVING DOWN YOUR ENERGY COSTS

Over 80% of a compressor's lifecycle cost is taken up by the energy it consumes. Moreover, the generation of compressed air can account for more than 40% of a plant's total electricity bill. To cut your energy costs, Atlas Copco pioneered Variable Speed Drive (VSD) technology in the compressed air industry. VSD leads to major energy savings, while protecting the environment for future generations. Thanks to continual investments in this technology, Atlas Copco offers the widest range of integrated VSD compressors on the market.

## Why Atlas Copco Variable Speed Drive technology?

- On average 35% energy savings during fluctuations in production demand with an extensive turndown range.
- Integrated Elektronikon Graphic controller controls the motor speed and high efficiency frequency inverter.
- No wasted idling times or blow-off losses in normal operation.
- Compressor can start/stop under full system pressure without the need to unload with special VSD motor.
- Eliminates peak current penalty during start-up.
- Minimizes system leakage due to a lower system pressure.
- EMC Compliance to directives (2004/108/EG).

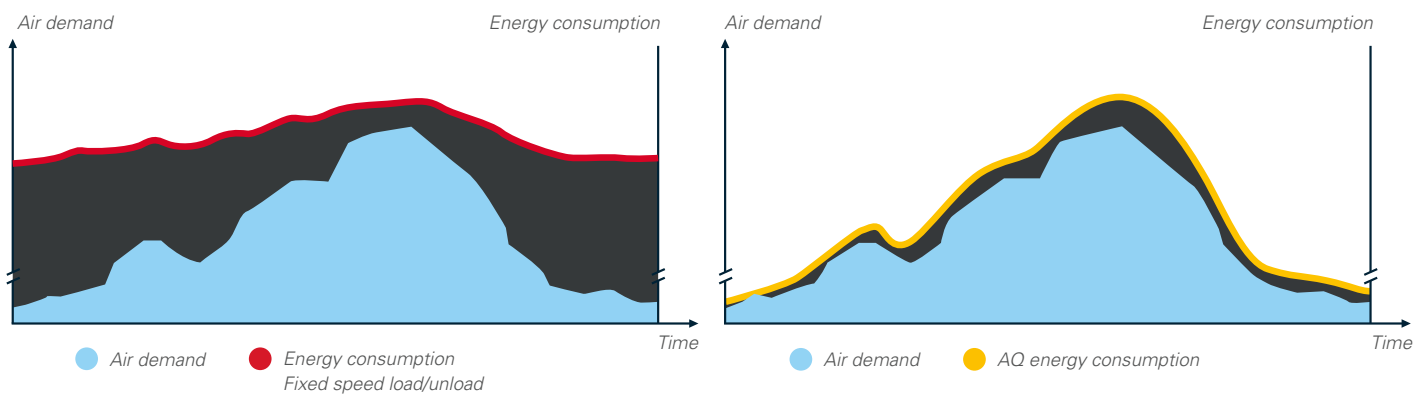

In almost every production environment, air demand fluctuates depending on different factors such as the time of the day, week or even month. Extensive measurements and studies of compressed air demand profiles show that many compressors have substantial variations in air demand. Only 8% of all installations have a more stable air demand.

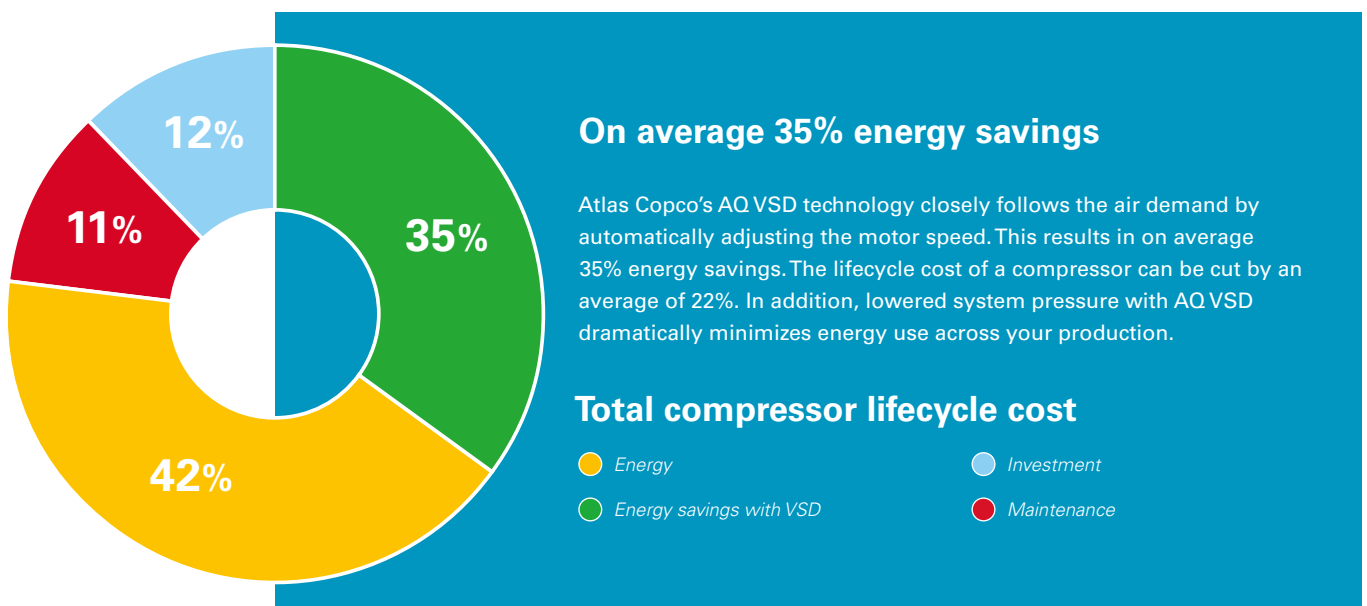

# How VSD technology saves energy

Contact your local Atlas Copco representative for an audit of your compressed air system. A real-time measurement simulation and audit report can be provided with recommendations for additional savings and sizing to meet your compressed air needs.

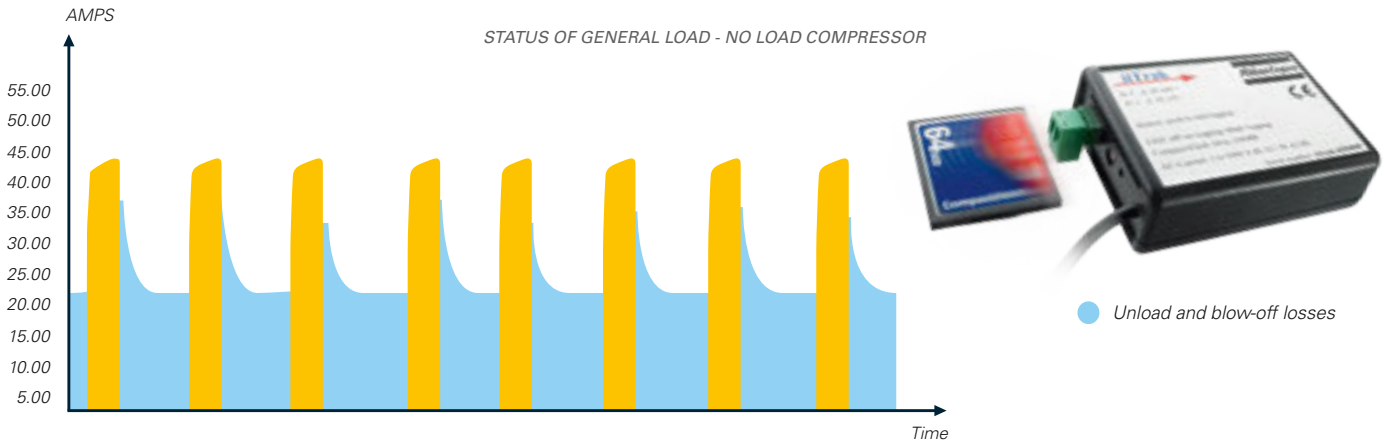

## What is unique about the integrated Atlas Copco AQ VSD?

- 1** The Elektronikon® controls both the compressor and the integrated converter, ensuring maximum machine safety within parameters.
- 2** Flexible pressure selection from 4 to 13 bar with electronic gearing reduces electricity costs.
- 3** Special electric motor specifically designed for VSD operation (inverter duty motor). Bearings are protected against induced bearing currents. Both motor and converter are perfectly tuned for highest efficiency across the entire speed range.
- 4** Electric motor specifically designed for low operating speeds with clear attention to motor cooling and compressor cooling requirements.
- 5** All Atlas Copco AQ VSD compressors are EMC tested and certified. External sources do not influence compressor operation, nor does the compressor affect the operation of other instruments via emissions or via the power supply line.
- 6** Mechanical enhancements ensure that all components operate below critical vibration levels throughout the entire compressor speed range.
- 7** A highly efficient frequency converter in a cool overpressure cubicle ensures stable operation.
- 8** No 'speed windows' that can jeopardize the energy savings and the stable net pressure. Turndown capability of the compressor is maximized.
- 9** The cubicle cooling booster increases the lifetime of electrical components due to a cool cubicle in overpressure and reduced dust ingress.
- 10** Offering precise control over pressure, net pressure band is maintained within 0.10 bar, 1.5 psi.

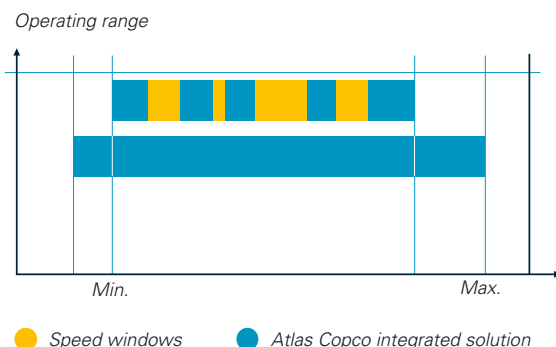
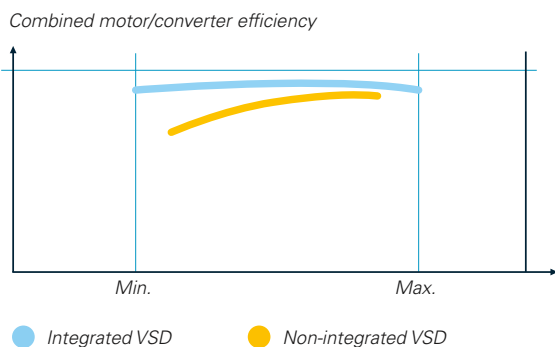

● Integrated VSD

● Non-integrated VSD

● Speed windows

● Atlas Copco integrated solution

# A STEP AHEAD IN MONITORING AND CONTROLS

The next-generation Elektronikon® operating system offers a wide variety of control and monitoring features that allow you to increase your compressor's efficiency and reliability. To maximize energy efficiency, the Elektronikon® controls the main drive motor and regulates system pressure within a predefined and narrow pressure band.



## Improved user-friendliness

- 3.5-inch high-definition color display with clear pictograms and extra 4th LED indicator for service.
- Graphical display of key parameters (day, week, month) and 32 language settings.
- Internet-based compressor visualization using a simple Ethernet connection.
- On-screen Delayed Second Stop function and VSD savings indication.
- Graphical indication Serviceplan, remote control and connectivity functions.
- Software upgrade available to control up to 6 compressors by installing the optional integrated compressor controller.



## Optional integrated compressor controller

Install, with a simple license, the optional integrated compressor controller and get simple, central control to reduce system pressure and energy consumption in installations of up to 4 (ES4i) or 6 (ES6i) compressors.

# OPTIMIZE YOUR SYSTEM

Some applications may need or may benefit from additional options and more refined control/air treatment systems. To meet these needs, Atlas Copco has developed options and easily integrated compatible equipment.

		AQ 15-30 VSD	AQ 37-55 VSD	AQ 30-55
Air treatment	Integrated refrigerant dryer	•	•	•
	Dryer bypass*	•	•	•
Extra protection	Thermistors & anti-condensation heaters	-	•	-
	Water shut off valve**	•	•	•
	Phase sequence relay	✓	✓	✓
Public works	Main power isolator switch	•	•	•
Connectivity	Elektronikon® Graphic Plus	•	-	-
	ES4i	•	•	•
	ES6i	•	•	•
	AIRConnect™	•	•	•
	IT ancillaries	•	•	-
	<b>SMARTLINK</b>	•	✓	✓
General options	Booster pump for RO system	•	•	•
	Flanged inlet	•	•	•
	Alarm horn	•	•	•
	Anchor pads	•	•	•
	Performance test report	•	•	•

\* FF units only.

\*\* Water-cooled units only.

✓ : Standard    • : Optional    - : Not available

## Flow diagram AQ air-cooled pack

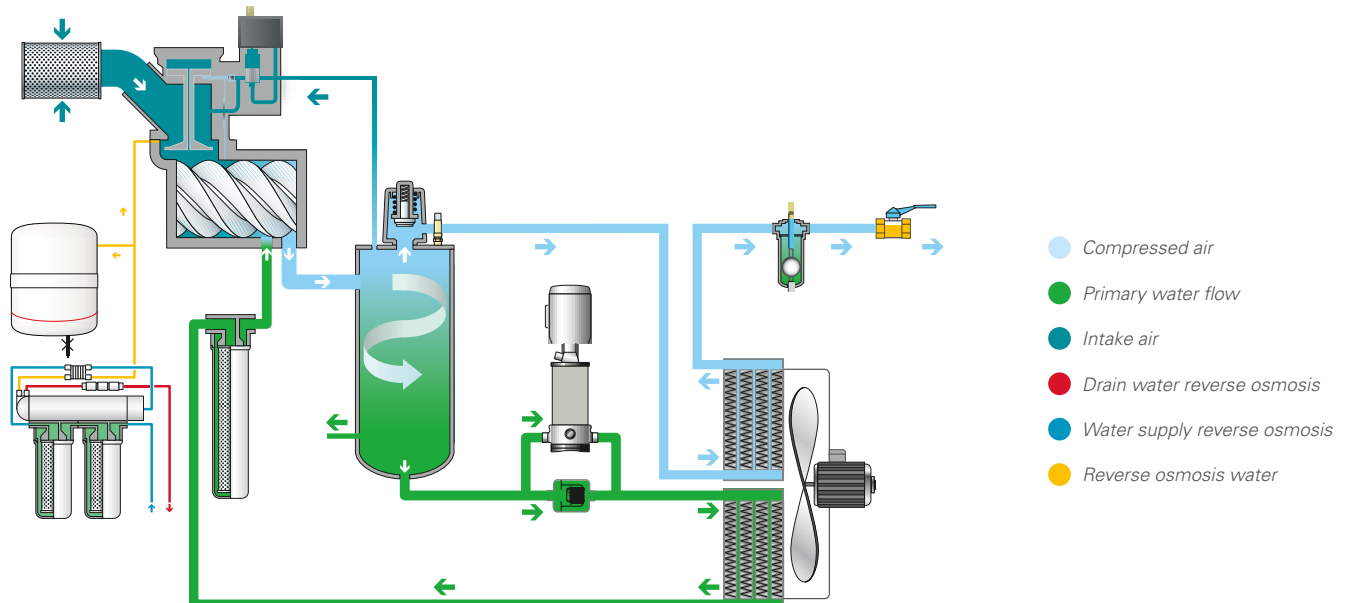

# TECHNICAL SPECIFICATIONS

## AQ 30-55 (50 HZ VERSIONS)

COMPRESSOR TYPE	Max. working pressure (bar(e)/psig)		Capacity FAD <sup>1</sup>			Installed motor power		Noise level <sup>2</sup>	Weight (kg/lbs)		
	Pack	Full Feature	l/s	m <sup>3</sup> /min	cfm	kW	hp	dB(A)	Pack	Full Feature	
<b>Air-cooled</b>											
AQ 30	7.5	7.5/109	7.25/105	81.8	4.9	173.4	30	40	68	1226/2703	1320/2910
	10	10/145	9.75/141	70.6	4.2	149.7	30	40	68	1226/2703	1320/2910
	13	13/189	12.75/185	61.0	3.7	129.3	30	40	68	1226/2703	1320/2910
AQ 37	7.5	7.5/109	7.25/105	102.3	6.1	216.9	37	50	69	1320/2910	1395/3075
	10	10/145	9.75/141	88.5	5.3	187.6	37	50	69	1320/2910	1395/3075
	13	13/189	12.75/185	75.4	4.5	159.8	37	50	69	1320/2910	1395/3075
AQ 45	7.5	7.5/109	7.25/105	122.2	7.3	259.1	45	60	71	1321/2912	1416/3122
	10	10/145	9.75/141	100.8	6.0	213.7	45	60	71	1321/2912	1416/3122
	13	13/189	12.75/185	88.2	5.3	187.0	45	60	71	1321/2912	1416/3122
AQ 55	7.5	7.5/109	7.25/105	138.6	8.3	293.8	55	75	72	1378/3038	1497/3300
	10	10/145	9.75/141	119.3	7.2	252.9	55	75	72	1378/3038	1497/3300
	13	13/189	12.75/185	102.1	6.1	216.5	55	75	72	1378/3038	1497/3300
<b>Water-cooled</b>											
AQ 30	7.5	7.5/109	7.25/105	88.1	5.3	186.8	30	40	65	1121/2471	1215/2679
	10	10/145	9.75/141	70.8	4.2	150.1	30	40	65	1121/2471	1215/2679
	13	13/189	12.75/185	54.7	3.3	116.0	30	40	65	1121/2471	1215/2679
AQ 37	7.5	7.5/109	7.25/105	106.8	6.4	226.4	37	50	66	1193/2630	1290/2844
	10	10/145	9.75/141	90.9	5.5	192.7	37	50	66	1193/2630	1290/2844
	13	13/189	12.75/185	72.6	4.4	153.9	37	50	66	1193/2630	1290/2844
AQ 45	7.5	7.5/109	7.25/105	128.2	7.7	271.8	45	60	67	1216/2681	1313/2895
	10	10/145	9.75/141	107.6	6.5	228.1	45	60	67	1216/2681	1313/2895
	13	13/189	12.75/185	89.6	5.4	190.0	45	60	67	1216/2681	1313/2895
AQ 55	7.5	7.5/109	7.25/105	152.4	9.1	323.1	55	75	68	1273/2806	1392/3069
	10	10/145	9.75/141	130.8	7.8	277.3	55	75	68	1273/2806	1392/3069
	13	13/189	12.75/185	108.7	6.5	230.4	55	75	68	1273/2806	1392/3069

(1) Unit performance measured according to ISO1217 Annex C, Edition 4, 2009.  
 (2) Mean sound level according to ISO2151, uncertainty 3 dB(A).

Reference pressure conditions:  
 - Absolute inlet pressure 1 bar (14.5 psi).  
 - Intake air temperature 20°C (68°F).

FAD is measured at the following working pressure:  
 - 7.5 bar versions at 7 bar.  
 - 10 bar versions at 9.5 bar.  
 - 13 bar versions at 12.5 bar.

### AQ 15-30 VSD

Height: 1500 mm, 59.1"  
 Depth: 974 mm, 38.5"  
 Width: 1976 mm, 77.4"

### AQ 37-55 VSD

Height: 1840 mm, 72"  
 Depth: 965 mm, 40"  
 Width: 2435 mm, 96"



# TECHNICAL SPECIFICATIONS

## AQ 30-55 (60 HZ VERSIONS)

COMPRESSOR TYPE	Max. working pressure (bar(e)/psig)		Capacity FAD <sup>1</sup>			Installed motor power		Noise level <sup>2</sup>	Weight (kg/lbs)		
	Pack	Full Feature	l/s	m <sup>3</sup> /min	cfm	kW	hp	dB(A)	Pack	Full Feature	
<b>Air-cooled</b>											
AQ 30	7.4	7.4/107	7.15/104	86.4	5.2	183.2	30	40	68	1226/2703	1320/2910
	9.1	9.1/132	8.85/128	81.1	4.9	171.9	30	40	68	1226/2703	1320/2910
	10.8	10.8/157	10.55/153	70.9	4.3	150.3	30	40	68	1226/2703	1320/2910
	12.5	12.5/181	12.25/178	66.2	4.0	140.3	30	40	68	1226/2703	1320/2910
AQ 37	7.4	7.4/107	7.15/104	103.5	6.2	219.4	37	50	69	1320/2910	1395/3075
	9.1	9.1/132	8.85/128	89.7	5.4	190.2	37	50	69	1320/2910	1395/3075
	10.8	10.8/157	10.55/153	85.5	5.1	181.3	37	50	69	1320/2910	1395/3075
	12.5	12.5/181	12.25/178	81.3	4.9	172.4	37	50	69	1320/2910	1395/3075
AQ 45	7.4	7.4/107	7.15/104	123.1	7.4	261.0	45	60	71	1321/2912	1416/3122
	9.1	9.1/132	8.85/128	106.6	6.4	226.0	45	60	71	1321/2912	1416/3122
	10.8	10.8/157	10.55/153	101	6.1	214.1	45	60	71	1321/2912	1416/3122
	12.5	12.5/181	12.25/178	96	5.8	203.5	45	60	71	1321/2912	1416/3122
AQ 55	7.4	7.4/107	7.15/104	145.5	8.7	308.5	55	75	72	1378/3038	1497/3300
	9.1	9.1/132	8.85/128	120.6	7.2	255.7	55	75	72	1378/3038	1497/3300
	10.8	10.8/157	10.55/153	122.1	7.3	258.9	55	75	72	1378/3038	1497/3300
	12.5	12/181	12.25/178	111.1	6.7	235.5	55	75	72	1378/3038	1497/3300
<b>Water-cooled</b>											
AQ 30	7.4	7.4/107	7.15/104	92.5	5.6	196.1	30	40	65	1121/2471	1215/2679
	9.1	9.1/132	8.85/128	82.4	4.9	174.7	30	40	65	1121/2471	1215/2679
	10.8	10.8/157	10.55/153	70.1	4.2	148.5	30	40	65	1121/2471	1215/2679
	12.5	12.5/181	12.25/178	61.3	3.7	130.0	30	40	65	1121/2471	1215/2679
AQ 37	7.4	7.4/107	7.15/104	110.9	6.7	235.1	37	50	66	1193/2630	1290/2844
	9.1	9.1/132	8.85/128	92.7	5.6	196.5	37	50	66	1193/2630	1290/2844
	10.8	10.8/157	10.55/153	87.2	5.2	184.9	37	50	66	1193/2630	1290/2844
	12.5	12.5/181	12.25/178	80.4	4.8	170.3	37	50	66	1193/2630	1290/2844
AQ 45	7.4	7.4/107	7.15/104	133.7	8.0	283.4	45	60	67	1216/2681	1313/2895
	9.1	9.1/132	8.85/128	114.8	6.9	243.4	45	60	67	1216/2681	1313/2895
	10.8	10.8/157	10.55/153	103.9	6.2	220.3	45	60	67	1216/2681	1313/2895
	12.5	12.5/181	12.25/178	97.5	5.9	206.7	45	60	67	1216/2681	1313/2895
AQ 55	7.4	7.4/107	7.15/104	161.4	9.7	342.2	55	75	68	1273/2806	1392/3069
	9.1	9.1/132	8.85/128	132.4	8.0	280.7	55	75	68	1273/2806	1392/3069
	10.8	10.8/157	10.55/153	131.2	7.9	278.1	55	75	68	1273/2806	1392/3069
	12.5	12/181	12.25/178	118.4	7.1	250.9	55	75	68	1273/2806	1392/3069

# TECHNICAL SPECIFICATIONS

## AQ 15-55 VSD (50/60 HZ VERSIONS)

COMPRESSOR TYPE	Max. working pressure (bar(e)/psig)		Capacity FAD <sup>1</sup>			Installed motor power		Noise level <sup>2</sup>	Weight (kg/lbs)	
	Pack	Full Feature	l/s	m <sup>3</sup> /min	cfm	kW	hp	dB(A)	Pack	Full Feature
<b>Air-cooled</b>										
AQ 15 VSD	13/188	12.75/185	22-47	1.3-2.8	47-100	15	20	67	650 / 1433	700 / 1543
AQ 18 VSD	13/188	12.75/185	22-54	1.3-3.2	47-114	18	25	69	650 / 1433	700 / 1543
AQ 22 VSD	13/188	12.75/185	22-66	1.3-4.0	47-140	22	30	70	740 / 1631	800 / 1764
AQ 30 VSD	13/188	12.75/185	22-83	1.3-5.0	47-176	30	40	72	740 / 1631	810 / 1786
AQ 37 VSD	13/188	12.75/185	43-105	2.6-6.3	93-223	37	50	69	1195 / 2635	1306 / 2879
AQ 55 VSD	13/188	12.75/185	43-147	2.6-8.8	93-311	55	75	72	1195 / 2635	1314 / 2897
<b>Water-cooled</b>										
AQ 15 VSD	13/188	12.75/185	22-47	1.3-2.8	47-100	15	20	67	542 / 1195	592 / 1305
AQ 18 VSD	13/188	12.75/185	22-54	1.3-3.2	47-114	18	25	69	542 / 1195	592 / 1305
AQ 22 VSD	13/188	12.75/185	22-66	1.3-4.0	47-140	22	30	70	632 / 1393	692 / 1526
AQ 30 VSD	13/188	12.75/185	22-83	1.3-5.0	47-176	30	40	72	632 / 1393	702 / 1548
AQ 37 VSD	13/188	12.75/185	42-108	2.5-6.5	89-229	37	50	66	1090 / 2403	1201 / 2648
AQ 55 VSD	13/188	12.75/185	42-155	2.5-9.3	90-328	55	75	69	1090 / 2403	1209 / 2665

(1) Unit performance measured according to ISO1217 Annex E, Edition 4, 2009.

(2) Mean sound pressure level according to ISO2151, uncertainty 3 dB(A).

## ***COMMITTED TO SUSTAINABLE PRODUCTIVITY***

We stand by our responsibilities towards our customers, towards the environment and the people around us. We make performance stand the test of time. This is what we call – Sustainable Productivity.



[www.atlascopco.com](http://www.atlascopco.com)

